

# U12 manual

1x12"/1x1.5" exit Point Source Module  
Operating & Flying Instructions



Thank you for purchasing the Quint Audio U12 loudspeaker.

This manual contains essential information on installing, flying and operating the product correctly and safely. It is necessary to read this manual carefully in order to become familiar with these procedures.

Keep the manual for future use. This manual forms an integral part of the product. Reselling of the product is only possible if the user manual is available. Any changes made to the product must be documented in writing and passed on to the buyer in the event of resale.

As part of a continuous evolution of techniques and standards, Quint Audio BV reserves the right to change the specifications of the product and the content of this manual without prior notice. Please check the Quint Audio BV web site at [www.quintaudio.com](http://www.quintaudio.com) on a regular basis for any updates.

Should the product require repair or should information about the warranty be needed, please contact an approved Quint Audio BV distributor. The address of the nearest distributor is available on the Quint Audio BV web site.

### Unpacking

Carefully open the shipping carton and check the product for any noticeable damage.

Each Quint Audio BV product is tested and inspected before leaving the factory and should arrive in perfect condition. If found to be damaged, notify the shipping company or the distributor immediately.

Only the consignee may initiate a claim with the carrier for damage incurred during shipping. Be sure to save the carton and packing materials for the carrier's inspection.



### Safety Warnings in this manual

This refers to potentially dangerous situations or dangerous forces that may lead to personal injury.



This refers to a potentially dangerous situation which may lead to damage to the equipment.



This refers to a situation which may cause the equipment to malfunction.



**Read this manual carefully before using the product.**

- Read all safety instructions, warnings and instructions concerning this product.
- Make sure you fully understand the safety issues mentioned.
- Read all cautions present on the product itself.
- Read all the related product information before using the system.
- Work with qualified personnel only.
- Rigging, hoisting and flying pro audio equipment is never free of potential hazards. You cannot rule out human error while gravity, wind and electrical forces do their regular job. Therefore: Always use your common sense!

**Personal safety**

Ensure health and safety during installation and setup. In order to prevent accidents when deploying loudspeakers on the ground or when flown, please take note of the following:

- The system may not be used for other purposes than it is meant for.
- All system components must be inspected before use, in order to detect any possible defects.
- Take into account the wind effects on dynamic load. If the wind force exceeds 6 Beaufort scale, lower down and/or secure the loudspeaker.
- Be cautious when flying a loudspeaker. Always verify that no one is standing underneath the loudspeaker array when it is being raised or lowered.
- Do not place the product on an unstable cart, stand, tripod, bracket, or table. The product may fall and be seriously damaged and may cause serious human injury.
- Never stand in the immediate vicinity of loudspeakers driven at a high SPL level. Professional loudspeaker systems are capable of causing a sound pressure level that is harmful to human hearing. Seemingly non-critical sound levels (from approx. 95 dB SPL) can cause hearing damage if people are exposed to it over a long period of time.
- Loudspeakers and amplifiers work with potentially harmful voltages. Avoid any direct contact with the human body. Respect electrical safety warnings at all times.
- Use certified connectors and cables. All cables must be electrically safe (according to NEN1010) and routed so that there is no direct walking on an/or driving over it nor objects are placed on top of them in any way it might damage the cable. Make sure that the cables and connectors are used stress free.



### General mounting and rigging instructions

- Respect the Working Load Limit (WLL) of Quint Audio equipment at all times.
- Respect the WLL of third party equipment at all times.
- Quint Audio is not responsible for any rigging equipment and accessories provided by third party manufacturers.
- Installation should only be carried out by qualified personnel who are familiar with and have knowledge of the rigging techniques used and with the safety recommendations stated in this and other eventually related manuals.



### Conditions which require immediate service

In all cases, when after an event risk of unsafe operation of the device, such as:

- After the damaged hitting any casing or cable.
- After a fall from the product resulting in visible or invisible damage.
- After mishaps and/or misuse and or possible visible or invisible deformation of any rigging system, rigging part or rigging accessory.
- After noticing a change in the operation of the device.
- After the product has been exposed to rain or moisture.
- After the product has been exposed to foreign objects or liquids.

### Magnetic field

Loudspeakers produce a static magnetic field even if they are not connected or are not in use. Therefore make sure when managing and transporting loudspeakers, they are nowhere near equipment and objects which may be impaired or damaged by their external magnetic field. Generally speaking, a distance of 0.5 m (1.5 ft) from magnetic data carriers (floppy disks, audio and video tapes, bank cards, etc.) is sufficient; a distance of more than 1 m (3 ft) may be necessary with computer and video monitors.

### Product monitoring, care and maintenance



- Regularly check all load bearing bolts and other metal parts in the mounting devices. Any parts showing any sign of (suspected) defect must immediately be put aside and withdrawn from use to be inspected by qualified service personnel.
- Regularly check the loudspeaker housings and accessories for visible signs of wear and tear, and replace them when necessary.
- Keep the loudspeakers away from heat producing sources such as heaters, stoves, fireworks etc. etc.
- Keep the loudspeakers away from water; prevent the possibility of water and moisture entering it.
- Even if the product is weather-resistant, it should not be exposed to moisture (rain, sea spray, shower, steam) for a long period of time, nor put in direct contact or immersed in water.
- Prevent objects and/or any liquid to enter the device.
- The loudspeaker housings can be cleaned with a damp cloth. Do not use aggressive cleaning agents or solvents as they can damage the protective layers.
- Small damages can be repaired with a water-based paint such as Warnex textured paint. The base layer however is an environmentally friendly polyurea. Damage to this layer can be repaired with polyurea, but this must be done by the manufacturer or a certified Quint Audio service point.
- The user should not carry out any work or maintenance on the system other than those mentioned in the manufacturers instructions. Technical service must be carried out by authorised technical personnel only.

## Design

The Quint Audio U12 is a 12 "/2.5" front loaded 2-way passively filtered full-range speaker system for universal use.

The U12 is built of birch plywood and equipped with a wear-, tear- and impact-resistant hybrid black coating (other RAL colors are available). Various internal bracings are applied in order to increase the rigidity of the design.

The 12-inch neodymium woofer of the U12 is equipped with a multiple demodulation-ring and features a 75 mm voice-coil which results in an improvement of the thermal, impedantive and dynamic behavior of the speaker.

The neodymium 1.4 inch exit high frequency driver features a quadruple ring-phase plug, which ensures an increased phase purity. The light and durable polymer membrane is driven by a 65 mm voice coil. The driver is mounted on a die-cast aluminum constant directivity horn with a precise opening angle of 80 degrees horizontally x 50 degrees vertically.

The dedicated passive filter is made up of very high-quality components. Air core coils are included in the signal path with a copper diameter of 2 mm. The applied foil capacitors have a working voltage up to 400 volts.

The U12 features M8 and M10 rigging points that facilitate both horizontal and vertical mounting. It also features an ergonomic handle on top and a 38 mm stand flange at the bottom of the speaker.

The front is finished by a coated steel grille and covered with an acoustically transparent layer.

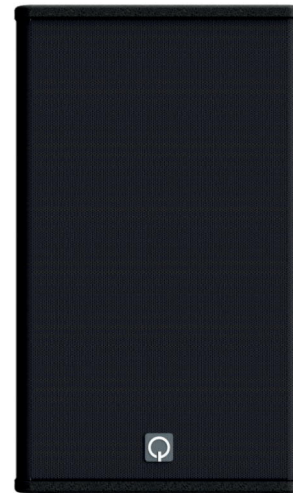

<b>MODEL</b>	<b>U12</b>
type	12"/2.5" universal full range 1point source system
filter	passive
power handling	500 W
program power	1000 W
impedance	8 Ohms
sensitivity	101 dB 1W/1m
program SPL	131 dB 1m
peak SPL	137 dB 1m
frequency range	54-19 kHz
dispersion	80°x50° h xv rotatable
weight	20 kg
size (wxhxd)	360 x 605 x 335 mm

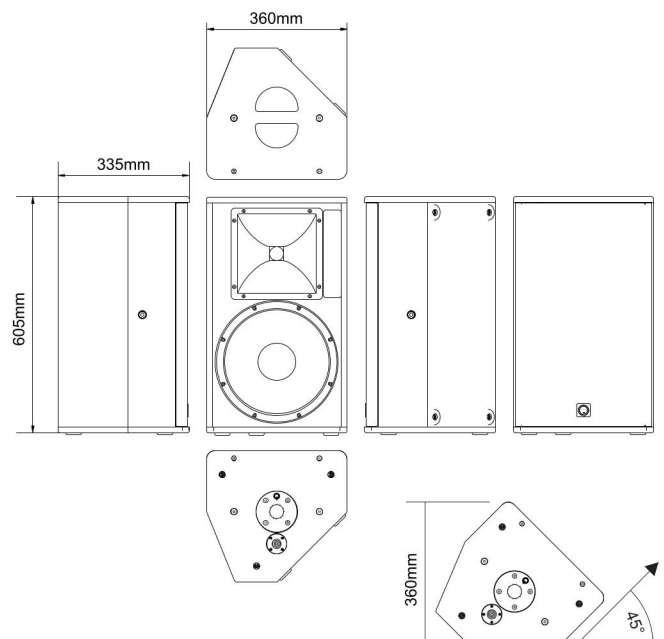

**Application**

With an incredible 101dB sensitivity the U12 is focusing on high efficiency reinforcement with a very large overhead in the middle tones area. This makes the U12 ideally suited for a powerful reinforcement of vocals, voice and percussive audio sources in sound pressure demanding environments.

The Quint Audio U12 is committed to near- and mid-field PA applications, in the area of live music, mechanical music and vocals, whether or not in combination with a subwoofer. Also the universal U12 can be excellently used as a high power, high SPL, high intelligibility floor monitor.

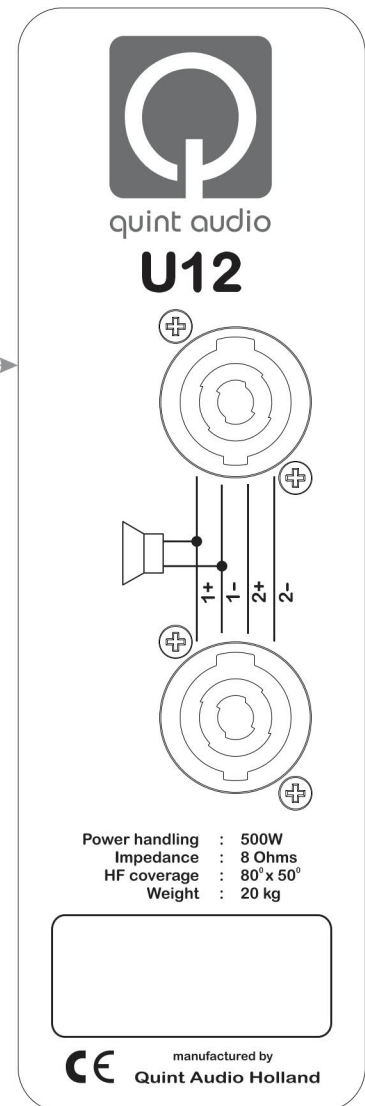

**Connectors and internal wiring of the loudspeaker**

The connection panel on the of the L10 cabinet is fitted with a pair of Neutrik Speakon NL4 connectors. All pins of both connectors are wired in parallel internally.

Pin assignments are stated on the backpanel (layouts on the right).

## Accessories

### U12-V1

U12 bracket for vertical mounting

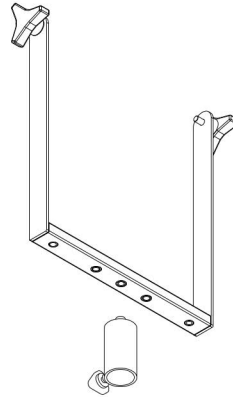

### SM-1

Universal stand mount 38mm

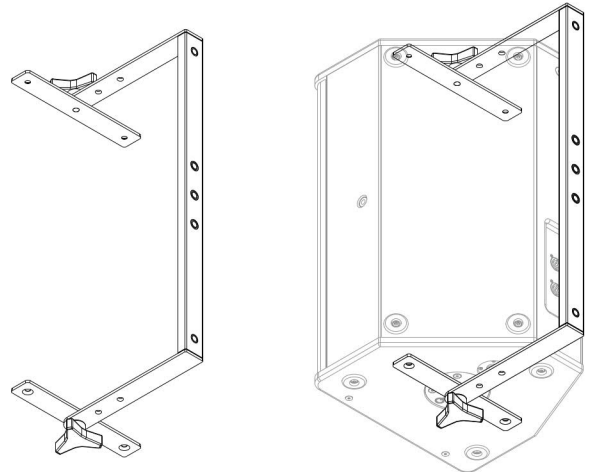

### U12-H1

U12 bracket for horizontal mounting

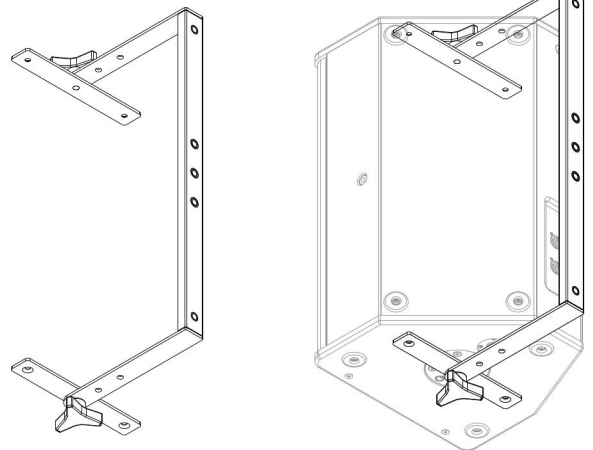

### U12-E1

U12 top mounted support plate

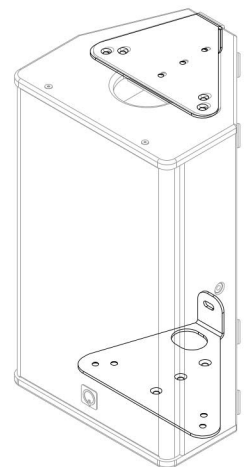
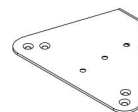

### U12-E2

U12 bottom mounted support plate

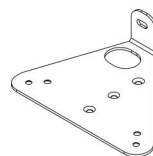



**Mohawk-1**

Universal rigging strip, to be mounted on top of support plate

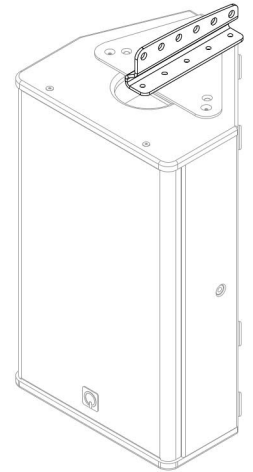
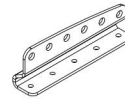

**U12-B1**

U12 backbone, universal mounting bracket, to be mounted in ombination with U12-E1 and U12-E2

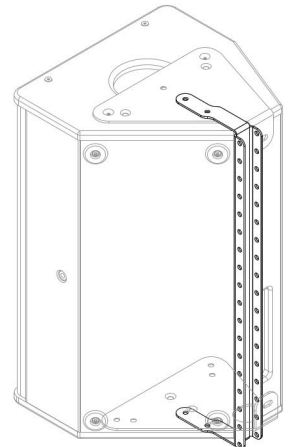

**Wall Bracket -1**

Universal wall bracket, horizontally hinged, supports several vertical mounting angles in combination with U12-B1

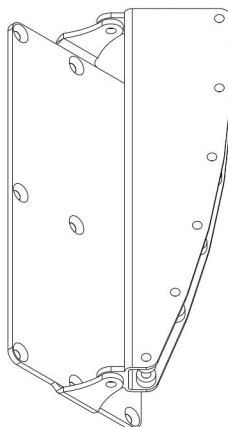

**Wall Bracket -2**

Bracket for mounting flat to the wall, in combination with U12-B1

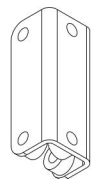

## Warranty

Quint Audio BV warrants the original purchaser and any subsequent owner of each new Quint Audio BV product, for a period of 5 years limited from the date of the original purchase by the original purchaser that the new Quint Audio BV product is free of defects in materials and workmanship. Quint Audio BV warrants the new product regardless of the reason for failure, except as excluded in this warranty. In order to obtain warranty, you must keep the original sales receipt to establish the exact date of purchase.

Warranty does not cover any product which has been damaged because of any misuse, accident, or negligence. Warranty also does not extend to a new Quint Audio BV product if the serial number has been defaced, altered or removed.

Quint Audio BV will replace defective parts and repair malfunctioning products, regardless of the reason for failure (except as excluded). Warranty work can only be performed at our authorized service centres, or at our factory.

## Disclaimer

Quint Audio BV is not liable for any damage to loudspeakers, amplifiers, or any other equipment that is caused by negligence, misuse or improper installation.

Quint Audio BV is not liable for any incidental damages resulting from any defect in the new Quint Audio BV product. This includes any damage to another product or products resulting from such a defect.

The information contained in this manual has been carefully checked for accuracy, at the time of going to press, however no guarantee is given with respect to the correctness.

Quint Audio BV by accepts no responsibility for any errors or inaccuracies that may appear in this manual or the products and software described in it.

Technical specifications, dimensions, weights and properties do not represent guaranteed qualities.

Quint Audio BV reserves the right to change specifications without notice.

# 5

**years limited warranty**

### EC declaration of conformity

This declaration applies to the product Quint Audio model L10. All product variants are included, provided they correspond to the original technical version and have not been subject to any later design or electro-mechanical modifications.



We, Quint Audio BV herewith declare that said products are in conformity with the provisions of the following EC directives including all applicable amendments.

States that the following products:

L10 rigging system is in conformity with the provisions of the following EC directives and applicable amendments:

Machinery 2006/42/EC and the national laws to enforce this directive, National standards and technical specifications applied: DIN EN ISO 12 100, DIN EN 1050, BGV C1 provided the mounting components are unaltered/modified and in "factory-original" condition.

Established at Wintelre, the Netherlands Aug 1th, 2019 A detailed declaration is available on request and can be ordered from Quint Audio BV.

### WEEE Declaration (Disposal)

Electrical and electronic equipment must be disposed of separately from normal waste at the end of its operational lifetime.

Please dispose of this product according to the respective national regulations or contractual agreements. If there are any further questions concerning the disposal of this product please contact Quint Audio BV.



## INDEX

2	Unpacking
3 - 5	Safety instructions
6	Design
7	Applications
7	Connectors / Internal wiring
8-9	Rigging accessories
10	Warranty
11	CE
11	Disposal
12	Index

### Copyright © 2020

Quint Audio. All rights reserved.

Except as permitted by applicable copyright law, no part of this publication may be reproduced, stored in a retrieval system, or transmitted, in any form or by any means, electronic, mechanical, recording or otherwise, without prior written permission from Quint Audio BV.

U-series is an alpha numeric designation for Quint Audio BV products and accessories are trademarks of Quint Audio BV.

All third-party trademarks mentioned herein are the property of their respective trademark holders.

Printed in the Netherlands